

# POLYTOUCH® FLEX 21.5 LITE



Pictures show sample configurations, real product may vary.



## DISPLAY

Front	1.2 mm strengthened glass
Coating	Anti-Glare
Surface hardness	7H
Display size	21.5"
Aspect ratio	16:9
Display type	Active matrix TFT LCD with LED backlighting, A+ Grade
Resolution	1920 x 1080 (Full HD)
Colors	16.7 million
Brightness	250 cd/m <sup>2</sup>
Viewing angle	Horizontal (left/right): 170° /vertical (up/down): 170°
Contrast ratio	1000:1
Backlight lamp life	typ. 30,000 hours to half brightness
Touch technology	PCAP, OGS

## COMPUTER UNIT

Processor	6 <sup>th</sup> /10 <sup>th</sup> Generation Intel® Core™ i
Chipset	Intel® Q170/Q470E
Graphics	Intel® HD 530/UHD 630
Memory	8 GB DDR4
Storage	128 GB mSATA SSD
LAN	2 x 1GbE LAN
WiFi	802.11a/b/g/n 2.4/5 Ghz with antenna (optional)
OS*	Windows® 11

\* optional

## POWER

Power input	C13, 100 – 240 V AC, 50/60 Hz
Power consumption	Average 50 W, peak 120 W

## SYSTEM

Material	Steel, powder coated
Dimensions (WxDxH)	5.95 x 12.53 x 22.78 in
Weight	13 kg
Mounting	Desk mount, wallmount, pedestal
Colour	RAL 9010

## CONFIGURATION

Scanner/Imager	Zebra MS4717 OR Datalogic Magellan 1500i
Payment ready	Verifone P400 OR Ingenico Lane 3000 OR

## ENVIRONMENTAL CONDITIONS

	Storage	Operating
Temperature	-20°C to +60°C	15°C to 35°C
Humidity	5% to 95% <sup>1</sup>	20% to 90% <sup>1</sup>

<sup>1</sup> non-condensing

## CERTIFICATIONS

CE, FCC

## PACKAGING & INDIVIDUAL WEIGHTS

	Weight net gross	Dimensions	Stack
Complete system	13 kg 15 kg	620 x 445 x 280 mm	max. 4 systemes on top of each other

## INTENDED USE/APPLICATION

The device is only to be used as a touch panel in combination with the intended fastening elements (pedestal, wall or table bracket). Other mounting elements must be specified accordingly for the device. The central component of the system consists of a computer with a touch screen. The touchscreen uses Projective Capacitive Technology (PCT) to recognize touch. The system is supplemented by built-in peripheral components. The device can be connected to an IT power distribution system.

## DIMENSIONS

Pictures show sample configurations, real product may vary.

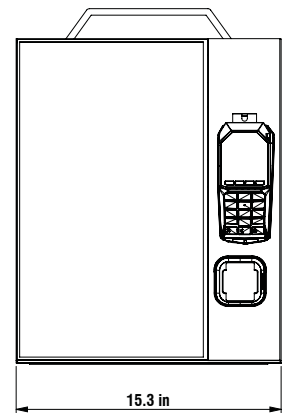
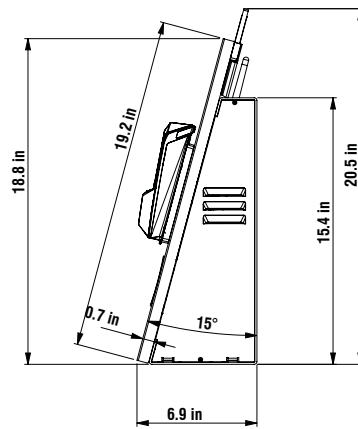
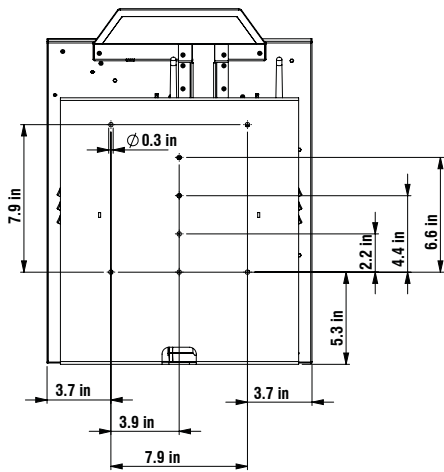

Variant Flex 21.5 lite incl. Magellan scanner, payment module and illuminated acrylic on top

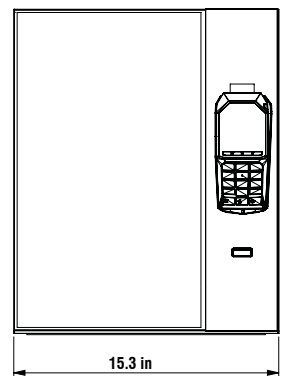
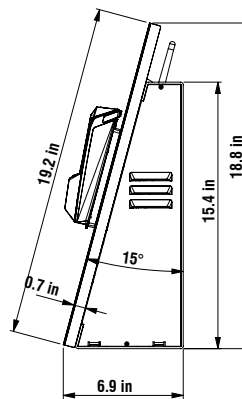
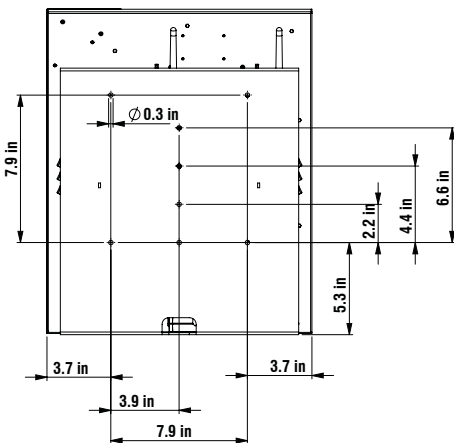

Variant Flex 21.5 lite incl. Zebra scanner and payment module

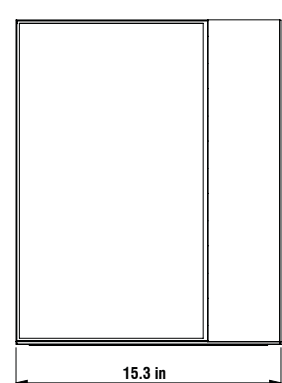
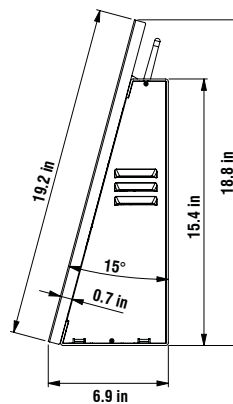
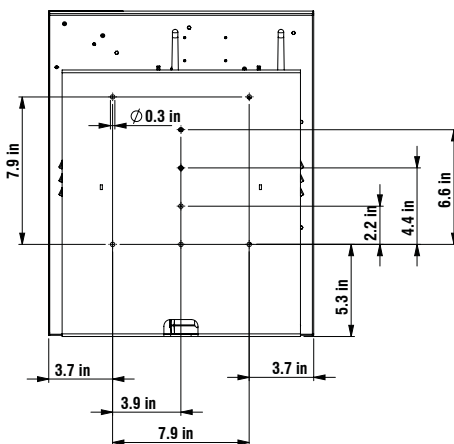

Variant Flex 21.5 lite only

# POLYTOUCH® FLEX 21.5 PEDESTAL



Pictures show sample configurations, real product may vary.



## PEDESTAL (INCL. BASEPLATE)

Material	Steel, powder coated
Dimensions (WxDxH)	16.5 x 16.4 x 29.5 in OR 16.5 x 16.4 x 33.9 in
Weight	Approx. 18.3 kg
Mounting	Floor bolting OR freestanding
Colour	RAL 7016 OR RAL 9005
Compatible with	POLYTOUCH® Flex 21,5 OR POLYTOUCH® Flex 21.5 ADA OR POLYTOUCH® Flex 21.5 lite
Accessories*	Freestanding baseplate, RAL 7016 OR Freestanding baseplate, RAL 9005

\*optional

## COLUMN

Dimensions (WxDxH)	5.2 x 8.1 x 29.5 in OR 5.2 x 8.1 x 33.9 in
Weight	Approx. 11 kg

## BASEPLATE ONLY

Dimensions (WxDxH)	16.5 x 16.4 x 0.2 in
Weight	Approx. 7.3 kg

## DIMENSIONS

Pictures show sample configurations, real product may vary.

